

Contents

WARNINGS	1	Anchoring	9	The Hull	17
Welcome Aboard	2	Boat Performance	10	Cleaning Unpainted Boats	17
Preparation	3	Running Your Motor	10	Cleaning Painted Boats	17
Recommendations For Safety	3	Propeller	10	Washing	18
Basic Flotation	4	Replace Damaged Propellers	10	Polishing	18
Level Flotation	4	Ventilation	11	Damaged Paint	18
Mandatory Equipment	4	Boat Running Attitude	11	Special Care for Moored Boats	18
Static Float Attitude	5	Steering Wheel Pressure	11	Important Notice about Ethanol	19
Practice, Practice, Practice	5	Performance	12	Trailer Information	20
Operating	5	Passenger and Gear Loading	12	Maintaining the Trailer	20
Fuelling Procedures	5	Trim Adjustments	12	Trailer Tips	21
Internal Built-In Fuel Tank	5	Instruments	13	Nautical Terms	22
Portable Fuel Tank	6	Electrical System	14	Warranty	23
Engine Use	6	General Maintenance & Repairs	15	3+2 Year Limited Hull Warranty	23
Advantages	6	Your Engine	15	Additional 2 year bonus	
Engine Starting	6	Cabin and Top Side Areas	15	Warranty	24
Before You Leave	6	Windscreens	15	Trailer Warranty	24
Necessary Maintenance	7	Stainless Steel	15	Obligations of Telwater	25
Manoeuvring	8	Seats	16	Pre Delivery Service	26
Basic Manoeuvring	8	Fabrics	16	20 Hour / 3 Month Service	27
Preparation	8	Canopy/Bimini Care	16	100 Hour / 12 Month Service	28
Approaching the Dock	8	Instruments and Gauges	16	Owner/Boat Identification	32
Mooring	9	Hull, Paint Service & Warranty	16		
Leaving the Dock	9	Oxidisation	16		

The hazard warning symbols shown are used throughout this manual. We urge you to read these warnings carefully and follow all safety recommendations.

These call attention to potentially dangerous situations which could lead to product damage, personal injury or death.

DANGER



Alerts you to immediate hazards which WILL cause severe personal injury or death if the warning is ignored.

CAUTION



Alerts you to hazards or unsafe practices which COULD result in minor personal injury, or cause product or property damage if ignored.

NOTICE



The symbol shown above calls attention to installation, operation or maintenance information which is important to proper operation, but is not hazard-related.

WARNING



Alerts you to hazards or unsafe practices which COULD result in severe personal injury or death if ignored.

Welcome Aboard

This manual has been prepared to assist you in the operation and care of your new boat. Please read it thoroughly as the contents can contribute to more effective operation of your boat.

Your boat's construction, including its mechanical and electrical systems (where applicable) were designed to meet safety standards in effect at the time the boat was constructed. Some of these standards were mandated by State law, others are considered industry norms. All these standards were designed to ensure your safety and the safety of other people, vessels and property around you.

To maintain the integrity and safety of your boat, only qualified people should perform maintenance on, or in any way modify your boat, the steering system, engine control system, fuel system or electrical system.

We strongly recommend you follow the instructions provided in this handbook and in the engine owner's manual, as well as the accessory instruction sheets included with your boat. We also recommend you perform the following steps:

Make certain you receive a full explanation of all systems from the dealer before taking delivery of your boat.

Read this manual thoroughly, paying particular attention to the subjects of fuelling, starting, loading limits, recommendations for safety and warranty.

Practice: all potential operating members of the family or friends should be familiar with the operation and systems of your boat.

Participate in a safe boating course if available.

Ensure you carefully read the 'Necessary Maintenance Label' located beside the compliance label inside your boat. Failure to adhere to these instructions may void all warranties.

WARNING



Grossly Negligent Operation can be a criminal offence.

Some examples of actions that may constitute negligent or grossly negligent operations are:

- Operating a boat in a swimming area,
- Operating a boat while under the influence of alcohol or drugs,
- Excessive speed in the vicinity of other boats or in dangerous waters,
- Hazardous water skiing practices and
- Bow riding, also riding on seat back, gunwale or transom,
- Operating the vessel in hazarded sea conditions beyond the vessels capability.

WARNING



A qualified, licensed operator must be in control of the boat at all times.

At night, turn on the appropriate running lights and cruise at a reduced speed. Allow plenty of time to avoid dangerous situations.

Preparation

Prior to leaving on your first outing (or, for that matter, any outing) there are certain items to check and activities to perform. Familiarise yourself with the boat before launching and consider the following suggestions:

Recommendations For Safety

Personal Flotation Devices: One approved Personal Flotation Device (PFD) of suitable size is required for each person aboard the boat. Always ensure children wear PFDs. Always check devices intended for young children for fit and performance in the water. Never hesitate to have all persons wear lifesaving devices whenever circumstances cause the slightest doubt about safety or where local boating regulations stipulate their use.

Underfloor Flotation: please be aware the polystyrene underfloor flotation material used in your boat is susceptible to degradation upon contact with petrol. Flotation material should therefore be checked regularly to assess its condition.

Do not overload or improperly load your boat. Maintain a clear walking area/freeboard at all times. Consider the sea conditions, the duration of the trip, the weather and the experience of the personnel on board. Do not allow any person to ride on parts of the boat not designed for such use. Sitting up on seat backs, bow riding (with the exception of boats that have been specifically designed to safely carry passengers in the bow section) and gunwale riding while underway can be especially hazardous. Raised casting platform seating positions are for use at rest, not whilst under-way.

Understand the meanings of navigation buoys and never moor to one.

Be aware of the various distress signals. Slowly raising arms up and down in a boat is a recognised distress signal.

Monitor weather forecasts before leaving and during your trip. Be especially attentive in areas where swimmers or divers may be operating.

Watch your wake. It might capsize a small craft. You are responsible for damage caused by your wake. Pass through anchorages at a minimum speed and observe speed limits where applicable.

Learn and abide by common boating "rules of the water."

Before commencing on an extensive cruise, have current charts of the cruising area on board.

Keep an alert lookout. Serious accidents have resulted from failure in this respect.

Always instruct at least one person on board in the fundamentals of boat handling, should you become disabled or fall overboard.

Consider what action you would take under various emergency conditions such as a person overboard, fog, fire, a damaged hull or other bad leaks, motor breakdown, severe storm or collision.

Note: This does not apply to models with a fully welded floor.

Your boat is not intended to act as a flotation device if capsized.

Should the boat ever capsize or a similar catastrophic event occur, the underfloor flotation installed may be compromised either by exposure to petrol, or through damage to the structure of the boat.

It is therefore imperative that appropriate safety gear is utilised whenever circumstances give rise to the slightest doubt about occupants' safety.

It is also strongly recommended you remain with your boat should any such event arise, since you are more easily located by search plane or boat.

Keep lifesaving and fire fighting equipment in good condition and readily available at all times. Monitor expiry dates also.

Have an adequate anchor and sufficient line (at least three to six times the depth of the water) to guarantee a secure hold in all types of weather and sea conditions.

Know your fuel tank capacity and cruising range. Your cruising range can be affected by many things, including weather conditions, tidal conditions, mechanical condition of your boat/motor and loading of your boat. If it is necessary to carry additional fuel, do so only in containers approved to carry fuel (per required regulations). It is good practice to allow a 50% margin over and above estimated fuel use.

Before departing on a boat trip, advise a responsible friend or relative of your intended route. Be sure to give that person a good description of your boat. Keep them advised of any changes in your cruise plans. These precautions will enable them to tell rescue organisations where to search and the type of boat to look for, if you fail to return. Be sure to inform that person upon return to prevent any false alarms about your safety.

The following is a representation of the Australian Builders Plate. Please familiarise yourself with the plate in your boat.

Basic Flotation

The boat will not sink with the passengers clinging to the side. ABYC H-5 calculates the required buoyancy for the boat to float with the hull, deck and superstructure submerged, supporting 25% of the load capacity and a proportion of the engines. Please note that the vessel can be in any attitude as long as it floats within 6 inches from the surface.

Level Flotation

The boat will remain upright when swamped, with passengers in the boat, in calm water. The boat is not self righting. ABYC H-5 places the buoyancy in proportion to the weight of the components, and their location in the boat.

The following is a sample plate of boats built with level flotation.

Australian Builders Plate

HIN Number Information Determined -	AUTRX-12345A606 ABYC Standards
--	-----------------------------------

Max 2 (s)	= 25hp*
	= 90kg[†]
Max 4	= 300kg
Max 2 + +	= 450kg

Bouyancy **BASIC FLOTATION**

⚠ Alteration of the boats hull or permanent fittings may invalidate the particulars on this plate.

⚠ A reduction in capacity must be taken into consideration when used in adverse conditions.

⚠ An additional safety feature of Level flotation is fitting to this vessel for the following capacity:

Max 3	= 255kg
Max 2 + +	= 360kg

Bouyancy **LEVEL FLOTATION**

Mandatory Equipment

All states have a list of mandatory safety equipment that must be carried on board at all times. There are different requirements for inshore and offshore operations with variations from region to region. Many dealers package the basic safety kit with the boat at the time of sale, be sure to obtain a copy of your state regulations to ensure you have everything required.

Look after safety equipment, store it carefully in the boat and regularly check it is all in good condition, especially life jackets, flares and other safety devices. Be sure to read the accompanying instructions and ensure you clearly understand how to use everything - particularly life jackets.

If you plan to carry children on board, check the life jackets are suitable for their size and weight. You may need to exchange jackets from the standard package to ensure the children have a style and size appropriate to their needs.

The following is a sample plate of boats built with basic flotation.

Australian Builders Plate

HIN Number Information Determined -	AUTRX-12345A606 ABYC Standards
--	-----------------------------------

Max 2 (s)	= 25hp*
	= 90kg[†]
Max 4	= 300kg
Max 2 + +	= 450kg

Bouyancy **BASIC FLOTATION**

⚠ Alteration of the boats hull or permanent fittings may invalidate the particulars on this plate.

⚠ A reduction in capacity must be taken into consideration when used in adverse conditions.

⚠ An additional safety feature of Level flotation is fitting to this vessel for the following capacity:

Your boat will contain one of the above plates to the appropriate flotation standard.

* Max hp for main propulsion.

† Max Kg is for combined engine mass including auxilliary.

Static Float Attitude

The static floating attitude of your boat can be affected by many variables. Optional equipment, passengers and loading of gear are the biggest contributors to a boat's lean. After launching, the floating attitude of any new boat can be adjusted. If your boat leans to one side, load items on the opposite side until the boat floats with a more level attitude.

HANDY TIP



Use fenders or fender boards to protect your boat's hull whenever mooring next to piers, docks or other boats.

Practice – Practice – Practice

Before attempting your first launch, tow the boat to a nearby empty parking lot and practice backing the trailer. Whenever you are backing up, be sure to have a lookout to help direct you.

Make sure the outboard is raised to clear obstacles. Remember to swing wide when towing around sharp turns to avoid cutting the corner with the trailer.

CAUTION



Your Boat is equipped with at least one transom drain plug. Make sure this plug is tightly in place. Failure to install the drain plug securely will result in the boat filling with water when launched.

Operating

Many people would love to own and use a boat, but are kept away from their dreams by fears they would not be able to launch, operate and retrieve a boat. This uncertainty is relieved with practice and experience and you will soon gain confidence.

The following sections are designed to give you the skills to become a more confident and aware boat operator on protected waters.

Fuelling Procedures

Internal Built-In Fuel Tank

If fuelling the boat whilst in the water, be sure it is securely moored to the dock.

Turn off all electrical equipment including the engine, appliances, bilge blower, lights etc.

Extinguish all cigarettes, cigars or other items that may produce a spark or flame.

Through-deck fittings are provided for fuel tank filling. Remove the cap and insert the fuel supply nozzle, allowing the nozzle to maintain contact with the fitting; this will prevent possible static sparking.

If, when filling the tank, you can't put fuel in at a reasonable rate, check the fuel vent line to see that it's not kinked or blocked. If the problem persists consult your dealer.

When you have finished fuelling, replace the fill cap and wash off any fuel spillage.

Fuel up on your way to the water, not on your way home or before you store your boat.

Allow for thermal expansion of the fuel on very hot days. Do not over fill the fuel tank.

WARNING



Spilt fuel may damage the paint work, the plastic side pocket material and the carpet on your vessel. If a fuel spill occurs insure it is cleaned up immediately.

Our boats have many different fuel tanks to suit our broad range. Some tanks are deeper than others. Depending on the fuel tank depth and the length of the fuel sender, the gauge may not give a true indication of the amount of fuel remaining in the tank when the gauge reads 'empty'.

The first time the tank is filled, have someone fill the tank slowly while watching the fuel gauge. As soon as the gauge moves (and remains) at a point above "empty" stop filling the tank and note the amount of fuel registered at the bowser. This is an indication of the fuel reserve in the tank. Never assume there is enough reserve in the tank to get home as the fuel gauge may read differently while at sea due to attitude, lean or list of the boat.

Portable Fuel Tank

Remove the tank from the boat for filling.

If your outboard requires a petrol/oil mix, follow the engine manual instructions for the proper lubrication oil and petrol ratio mix.

Before placing the tank back in the boat, wash off any spilled fuel.

Some portable tanks have vent screws which must be open during engine operation.

WARNING



Do not use fuels that incorporate any form of alcohol or alcohol derivatives or ethanol. Alcohol and ethanol's may destroy marine fuel system hoses and components, which could lead to hazardous leaks, fire or explosion.

WARNING



The flotation material used in your boat can be affected by petrol and petroleum based products. Check the condition of the flotation material periodically by removing the floor. If a petroleum-based product is spilt inside your boat, check the condition of the flotation material prior to your next trip.

Engine Use

The engine operating and maintenance manual provided with your boat describes pre-start and starting procedures. Modern engines are designed to be started in a particular way. Read the starting procedure for your engine carefully prior to attempting operation.

Special Note: The following advantages and disadvantages of a Lanyard Stop Switch should be considered before electing to use such a switch.

Advantages

The purpose of a Lanyard Stop Switch is to stop the engine when the operator leaves the control station, either accidentally by falling in the boat or by being ejected overboard. This is most likely in certain types of boats such as low sided models or high performance boats. And/or as a result of poor

operating practices such as sitting on the back of the seat or standing at planing speeds, operating at high speeds in shallow or obstacle infested waters, drinking and driving, or daring high speed boat manoeuvres.

Disadvantages

Inadvertent activation of the switch is also a possibility. This could cause any or all of the following potentially hazardous situations:

1. Loss of balance and falling forward of unstable boat passengers – particularly in low bow rider style boats.
2. Loss of power and directional control in heavy seas, strong current or high winds.
3. Loss of control when docking.

WARNING



As we cannot possibly know of and advise the boating public of all conceivable boat/power package types and/or poor operating practices, the final decision of whether or not to use a Lanyard Stop Switch rests with you, the owner/driver. It is recommended that the lanyard be attached to the driver/operator when ever the engine is in operation.

Engine Starting

DO NOT continuously operate the starter for more than 15 seconds at a time.

On boats so equipped, check the oil pressure, voltmeter and temperature gauges immediately after the engine starts. Make a visual check to ensure a strong jet of water is squirting from the engine tell tail. Lack of water here may indicate a faulty impeller or a block in the tell tail or water intake. Try clearing the outlet with a suitable piece of wire before proceeding, or contact your nearest dealer.

Before You Leave

Providing you have not encountered any problems, you are almost ready to go. (If you did encounter problems, do not attempt to operate your boat until they are corrected). Before you leave, perform the following steps:

- Check the operation of equipment such as bilge pumps, running lights, radios, etc. Check the steering. Turn the steering wheel to a complete lock, clockwise and anti-clockwise, to ensure that there is free movement.
- Instruct passengers in the use and location of flotation devices.
- Obtain a reliable weather forecast and plan accordingly for everyone's comfort and safety.
- Notify a responsible friend or relative of your intended path. Upon your return or a change in your cruise schedule, notify that person again to avoid unnecessary concern.
- Ensure everyone is seated (in or on a seat).
- Be certain any operator has not been or is not consuming alcoholic beverages/or non prescribed drugs.
- With all pre-departure checks now completed, you are ready to leave the dock.

NECESSARY MAINTENANCE



Hose inside boat after use with a substantial quantity of fresh water.

Leave boat permanently tilted to drain after use.

The flotation material is susceptible to degradation upon contact with petrol.

Flotation material should be checked regularly to assess its condition. (example of Necessary Maintenance label)

HANDY TIP



Carry plenty of rope that is properly sized for your boat. We suggest at least two 10m lengths of 10mm rope.

HANDY TIP



When commissioning a new boat, do not plan an extensive trip until you are sure all equipment is functioning properly and you are familiar with the boat's operation.

Cross-section Standard Fuel Tank

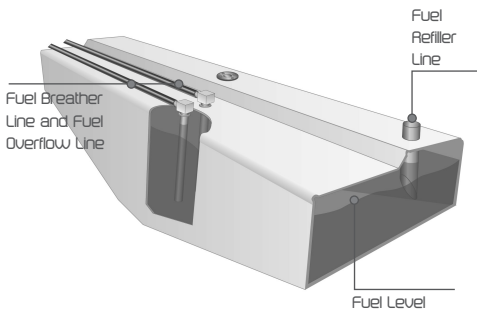

Cross-section Standard Fuel Tank

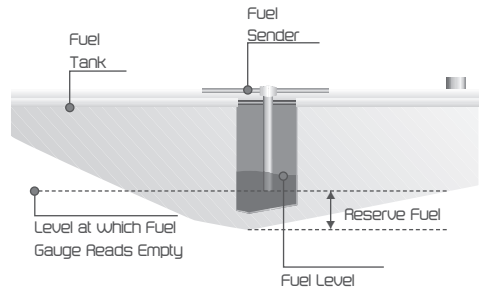

Basic Manoeuvring

Remember all boats steer by the stern (the feeling is much like steering your car in reverse). For example, when turning the steering wheel to the left, the stern of the boat will swing to the right as the boat goes into a left turn. This is particularly important to remember when docking, or in close quarters with other boats.

There are no brakes on a boat. Stopping is accomplished by allowing the boat to slow down (under 10 km/p/h) and putting the engine in reverse. Gently increasing reverse power allows you to stop the boat in a very short distance. A boat does not respond to steering in reverse nearly as well as it does when going forward, so do not expect to accomplish tight turning manoeuvres when backing up.

Once you are away from the dock, devote some time to learning how to manoeuvre:

- Practice docking by using an imaginary dock.
- Practice stopping and reversing.
- When operating in close quarters or docking, all manoeuvring should be done at idle speed.
- Proceed with caution in congested areas.
- Gradually increase your speed. Familiarise yourself with the boat before attempting any full throttle operation.

Preparation

Proper docking requires preparation. Start by making sure you have adequate mooring gear that is stowed correctly and ready for use. Your dealer is the best source for information concerning the amount and type of equipment you should carry.

Approaching the Dock

When approaching a dock, lower your speed within reasonable distance to allow the wake to subside before it reaches other boats, or docks.

As you get close to the dock, check for any wind or current action that may affect your manoeuvre, then make a conservative approach with these factors in mind. Try to use the elements to your advantage. Allow them to carry the boat into the dock. If there are high winds or strong currents, it is best to approach from the lee side (against the wind and current). With a mild current and little or no wind, it is best to approach from the windward side (with the wind and current).

While approaching, ensure all lines are attached to the cleats on the side facing the dock. Also ensure fenders are lowered on the same side. Be sure to check the fenders are hung at the proper height.

Basic Manoeuvring Principles

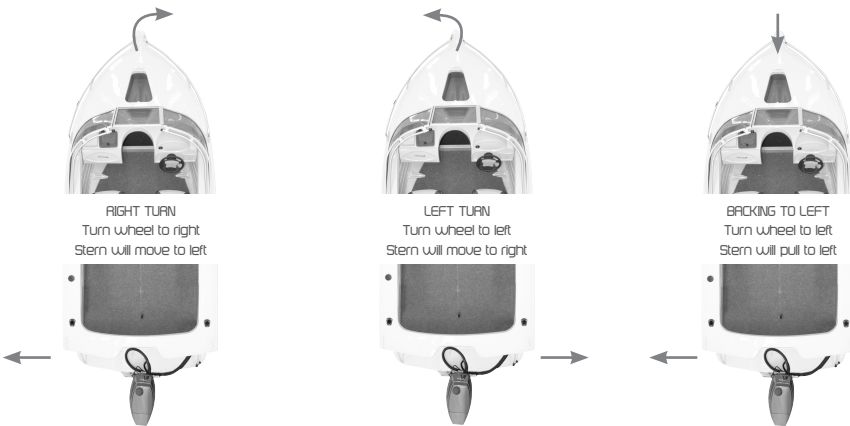

Approach at idle RPM at an angle approximately 45 degrees to the dock. When the bow is within a few metres of the dock (starboard side) the stern can be brought alongside by turning hard to port. Next, turn to starboard and at idle RPM put the boat into reverse. This will stop the boat and bring the stern closer to the dock. These steps are reversed for docking to port. A precaution should be taken not to allow limbs between the boat and the dock.

Mooring

To attach lines to deck cleats, make a loop in one end of the line and pass it through the hole in the base of the cleat; then pass the loop back over the entire cleat. The line can now be used to secure the boat. Lines may be kept this way while underway, providing they are coiled and cannot become tangled in deck gear or props. In heavy sea conditions, all lines should be removed from the deck. Fenders should also be used when mooring the vessel to protect the side of the vessel.

HANDY TIP



To tie up, run the line from the boat around the dock cleat and then back to the boat. This way you can untie the line without jumping from the deck to dock and back again. Instead, just cast off one end of the line and bring the whole length back on board.

Leaving the Dock

Take into account the wind, tide, current and other forces that affect manoeuvring when leaving the dock. Most manoeuvring to and from a dock is best accomplished at idle speeds. Do not forget to release the mooring lines and stow the fenders.

When leaving a dock on the starboard side and the bow cannot be pushed away from the dock first observe the following points:

Start forward with the steering wheel turned to starboard for two or three feet.

Then shift to reverse with steering full to port.

Repeat if necessary to shift the stern far enough away from the dock to be clear of other boats that may be moored ahead. (Reverse these steps when leaving a dock located to port.)

DO NOT tow your boat or use your boat to tow other boats:

Damage caused to a boat due to towing behind another vessel or towing another vessel WILL NOT be covered under warranty. The stress caused by towing in this way is outside the design specifications for our boats. A customer using a boat as a tender for a larger vessel must transport the boat on the larger vessel.



WARNING

- Use caution with skier in tow as tow rope may backlash into cockpit when released,
- Only tow water skis, wakeboards or recreational towables,
- Do not tow parasails, kites, other boats or any device that is designed to become airborne when towed behind a boat,
- Do not tow more than one person at one time,
- Always wear an approved personal flotation device (PFD),
- Do not allow anyone near the propeller(s), even when engine is switched off. Propeller blades can be sharp and can continue to turn after engine is off.

Anchoring

Pick a spot where the boat has room to swing around the anchor without hitting other boats or objects.

Avoid anchoring in channels or narrows where you may interfere with traffic. You could cause another boat to run aground or you might be run down by larger craft.

Never tie up to, or obstruct the view of a buoy. This contravenes marine law.

Approach the site slowly, keep the bow into wind or current, whichever is stronger. Drift into position and lower the anchor.

When anchoring, lower the anchor and chain from the bow - don't drop or throw it. When the anchor reaches the bottom, drift or reverse slowly until the anchor holds. Feed out line 3 to 6 times the depth of the water. Keep feet and legs clear of the line.

Turn the line around the bow cleat and tie a hitch.

To raise the anchor, inch forward under power as you take in line. When the line is vertical, raise the anchor. If it's not free, tie the line off on a cleat and then circle the anchor slowly, keeping the line under strain.

Don't let the line get close to the propeller.

Boat Performance

Boat speeds are affected by many factors. Some such as temperature and altitude, cannot be changed, but some factors can. When loading, only take the necessary equipment with you. Keep weight at the lowest level possible and evenly distributed. Weeds, barnacles and other growth will degrade performance. Keep the bottom of the boat clean. When the boat starts "growing grass", it will slow down greatly.

Running Your Motor

Outboard engines usually deliver their best fuel economy at around 4,000-4,500 rpm. So, always try and set the boat up in this range when travelling any distance. The amount of load in the boat will also influence fuel economy to a degree, so don't fill the boat up with unnecessary items.

If you do not have a tachometer to monitor revs, locate a spot between half and two thirds throttle where the hull is sitting up on top of the water and planing cleanly. It is likely the optimum rev range is at this point.

Propeller

Propellers have two basic characteristics, 1) diameter and 2) pitch. Diameter applies to the circle inscribed by the blade tips, measured in inches. Pitch is the theoretical distance (measured in inches) a propeller travels when it has rotated one complete revolution. For example, a propeller with a 21 inch pitch, when rotated 360 degrees advances 21 inches through the water. Because of the essential phenomenon of blade angle attack and slippage, a propeller cannot advance further than about 90 percent of the pitch number, though 80 to 85 percent is quite common.

1) Diameter

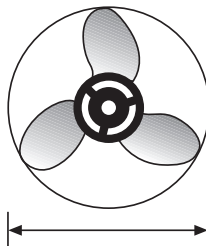

2) Pitch

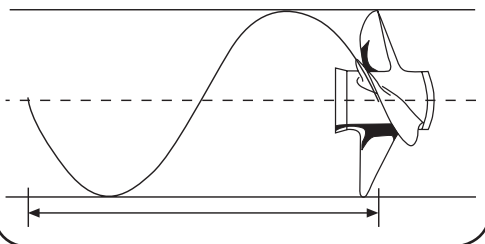

DANGER



Persons in the water can be seriously injured, or killed if struck by a rotating propeller. Operate the motor only when an operator is seated securely at the controls. Turn the motor off when swimmers are entering or leaving the boat or in the water near the stern.

Replace Damaged Propellers

Propellers should be free from major nicks, excessive pitting and any distortions that alter the original design.

Operating your boat with a damaged propeller may cause the following:

- Reduce top speed.
- Introduce undesirable handling characteristics
- Reduce fuel economy.
- Create unpleasant vibrations leading to increased sound level. Excessive vibrations hasten wear to rotating and reciprocating engine components, which may cause costly damage.

Ventilation Causes Less than Optimum Performance

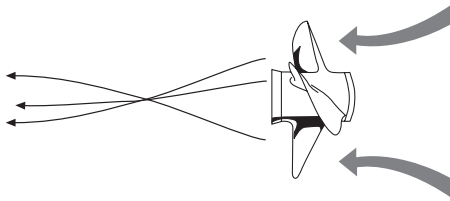

OPTIMUM PERFORMANCE

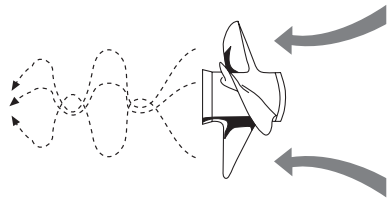

VENTILATION

While often called cavitation, ventilation is really a different effect.

Ventilation

While often called cavitation, ventilation is really a different effect. At times when a boat enters or leaves a sharp turn, the propeller seems to slip and lose thrust and the engine may over rev. This problem is normally caused by air or aerated water entering the propeller. This can be rectified by one or more of the following:

- Replace a damaged or incorrect propeller.
- Set outboard at a lesser trim angle (trim unit inward).
- Use a cupped propeller if one is not already in use.
- Contact your dealer to check the motor height.

Boat Running Attitude

If your boat runs with the bow too high at cruising speeds, observe the following points to achieve a more correct and efficient cruising attitude:

Move some weight forward in the boat.

Adjust the thrust angle of the engine (reduce the distance between the bottom of the transom and the drive unit).

This is commonly referred to as trimming down or in, or applying 'negative trim'. See your engine owner's manual for further trimming instructions.

If your boat runs with the bow too low at cruising speeds (usually indicated by water coming off the hull too far forward and steering difficulty or veering off course). Raise the bow by performing the opposite of the steps above. This is referred to as trimming up or out, or applying 'positive trim'.

For maximum effectiveness when planing, the hull should be at a 3 to 4 (three to four) degree angle to the water.

Steering Wheel Pressure

This pressure, or pull, is corrected by adjusting the trim position of your outboard so the prop shaft is parallel to the surface of the water. If this is not possible, the trim tab located under the aft end of the anti-ventilation plate can be adjusted by your dealer.

The trailing edge of the trim tab should be turned in the direction the boat is pulling. Small adjustments should be made until the steering has neutral torque (pull) at the desired speed.

We suggest using your normal cruising speed. When running faster or slower than this speed, a minimal amount of torque will be present.

WARNING



There is a risk of falling or ejecting out of the boat if standing or moving while the boat is in motion. If someone must stand while the boat is in motion, avoid speed changes that could cause the standing person to lose balance. Bow riders should not have people in the bow standing or kneeling or changing positions while the boat is in motion.

Passenger and Gear Loading

As passengers occupy different seat positions you will notice the boat's speed change. Passengers must never change seat location while the boat is moving. As this shift in passenger weight alters the planing angle of the hull in much the same manner as though the drive unit angle were changed (trim was altered).

A shift of passenger or gear load forward or aft will often correct minor boat riding deficiencies.

Take care when placing items such as cooler box, water jugs, tackle box, anchor, tools, portable fuel tanks, etc., to help create more desirable running attitudes.

For best boat and motor performance, the boat should be trimmed as described in "Boat Running Attitude" or to suit the prevailing conditions. Passengers and equipment should be distributed in the boat so it is evenly balanced both front to back and side to side.

WARNING



Your boat has been constructed for normal boating conditions. Using your boat in adverse conditions or outside of its design limits could affect it structurally and may void your warranty. It is the operator's ultimate decision on what conditions the boat is used in.

Instruments

While under way, instruments should be checked frequently for possible indications of trouble.

Tachometer (if fitted)

A tachometer is an electrical instrument that indicates engine Revolutions Per Minute (RPM). The tachometer is useful for monitoring engine speed to avoid exceeding the maximum RPM rating. In addition, it can be used to detect performance changes by comparing speedometer readings at various RPMs.

Passenger and Gear Loading

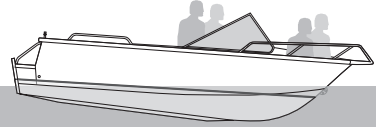

INCORRECT
Overload Forward Causes Boat To 'Plow'

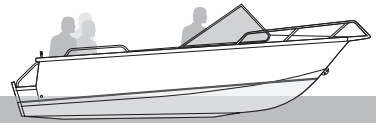

INCORRECT
Overload Aft Causes Boat To 'Porpoise'

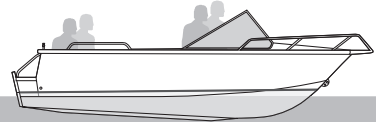

CORRECT
Balanced Load Gives Maximum Performance

Trim Adjustments

When trimming the engine from a mid-trim position (trim tab in neutral straight fore-and-aft position), expect the following results:

Trimming engine up (out) characteristics:

- Will lift bow of boat, generally increasing top speed.
- Transfers steering torque harder to left on installations below 23" (58 cm) transom height.
- Increases clearance over submerged objects (depends on speed/latitude)
- In excess, can cause porpoising and/or ventilation.
- If trimmed out beyond the water pickup, reduced water supply can cause serious overheating.

Trimming engine down (in) characteristics:

- Will help you get on the plane quicker, particularly with a heavy load.
- Usually improves ride in choppy water.
- In excess, can cause boat to veer to the left or right (bow steer).
- Transfers steering torque harder to right (or less to the left).
- Improves planing speed acceleration (by moving tilt pin one hole closer to transom).

Trimming the Engine for Maximum Performance

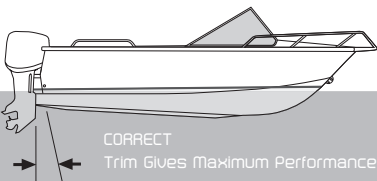
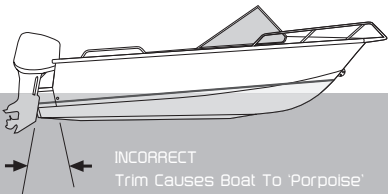

WARNING



Excessive trim out also may reduce the stability of some high speed hulls. To correct instability at high speed, reduce the power GRADUALLY and trim the motor slightly before resuming high speed operation. Rapid reduction in power will cause a sudden change of steering torque and may cause additional momentary instability.

WARNING



Excessive speed at minimum trim in may cause undesirable and/or unsafe steering conditions. Each boat should be tested for handling characteristics after any adjustment is made to the tilt angle (tilt bolt relocation).

Temperature Gauge (if fitted)

The temperature gauge indicates engine coolant temperature by monitoring a signal from a sending unit installed in the engine water jacket. When the gauge reads in the danger area, shut off the engine and diagnose the problem.

A common cause of overheating is picking up a foreign object in the water intake. Usually, raising and lowering the outboard will free it. Backing up in reverse gear, then pulling ahead in forward gear for 2 - 3 (two to three) metres is helpful too.

Oil Pressure Gauge (if fitted)

The oil pressure gauge indicates engine lubricating oil pressure. Low oil pressure readings are generally caused by low oil quantity. In any case, immediately shut down the engine and diagnose the problem.

Fuel Gauge (if fitted)

The fuel gauge indicates fuel level. Since boats are exposed to rough water conditions and varying degrees of trim, fuel gauge readings are often inaccurate. It is always good to keep track of your running time as a double check against an inaccurate gauge.

Compass (if fitted)

Many factors affect the operation of your compass, such as local magnetic variation and deviation (induced needle deflection caused by metal components and the operation of electrical equipment aboard your boat). Each compass must be 'swung' (compensated) to adjust for individual boat characteristics, and for the particular compass installation. It is vitally important, therefore, that you have your compass professionally swung before using it for serious marine navigation. Contact your dealer for more details.

Electrical System

Battery (if fitted)

The key to a good marine electrical system is the battery. On some models the condition of the battery can be read on the voltmeter when the ignition switch is in the ON position.

With the engine not running, voltmeter readings in the 11.5 to 12.5 volt range are considered normal. Readings in the 10 to 11.5 volt range indicate a marginal charge condition. Readings below 10 volts indicate a seriously discharged condition.

With the engine running (over 1500 RPM), voltmeter readings of 13 to 14 Volts are considered normal. Readings below this indicate a severely discharged battery or a non-functioning charging system.

Check the battery electrolyte level regularly. Remove the caps on top of the battery and observe the level of the fluid inside. If the zinc plates are exposed, add distilled water until they are covered again. Corroded terminals can impair battery performance and charging ability.

Clean terminals with baking soda and water; then coat with a preservative or a light film of grease. Be sure all battery connections are tight. When storing the boat, it is best to remove the battery, give it a full charge and store inside away from extreme temperatures.

HANDY TIP



Before each trip ensure the battery is fully charged and the charging system (if applicable to your model) is fully operational. Insure the battery CCA (cold cranking amps) rating is suitable for the engine fitted to the vessel.

General Maintenance & Repairs

In addition to instructions found elsewhere in this manual and in the literature specific to certain components, the following information is provided for general maintenance and repair.

Because conditions vary widely in different areas and the frequency and type of use can differ greatly between owners, intervals for maintenance are not listed here. Use the appropriate engine owners' manual and common sense to determine the frequency of maintenance. Your vessel will require maintenance to insure the condition of your vessel doesn't deteriorate. For specific engine usage, maintenance and repair guidelines refer to the appropriate outboard owners' manual.

Your Engine

If you use your boat infrequently, it is advisable to buy a freshwater engine flushing connection appropriate to your particular engine. Turn the hose on, then when water is coming through the tell-tail, start the engine and run it for a few minutes. This will flush away residual salt and keep the motor in good shape.

A common cause of outboard failure is a blockage in the fuel supply, or contaminated fuel. If operating off a carry tank fuel supply and the motor simply sputters out, check two things first.

Ensure the tank has not been placed on a section of the hose pinching it closed.

If you have the type of tank that requires it, make sure the cap is ventilating properly.

Many models are set up in the factory with a water separator, which takes care of water in the fuel. This can be caused by something as simple as condensation in the tank. If using carry tanks, familiarise yourself with the position of the small filter fitted to the engine. Cleaning this will often get you underway again.

Because water sinks to the bottom of a fuel tank, placing the carry tank on an angle - or parking the boat on an angle in the case of underfloor fuel tanks - causes all the water to collect in the lowest corner of the tank. A syphon pump can then be used to remove all of the water.

Contaminated fuel is rare, but it is advisable to understand its implications.

Cabin and Top Side Areas

Check your entire boat from time to time. Check bow rails, ladders and grab rails for loose screws, breaks, sharp edges, etc., that might be hazardous. Check inventory and inspect life jackets for tears and deterioration. Check signaling equipment. Inspect anchor, mooring and towing lines and repair or replace as required. Do not stow wet lines since mould and mildew may result.

Windscreens

Salt and brackish water are capable of etching and damaging windscreens and windows. Keeping windows clean is the best preventative measure to take. When window cleaning, flush with fresh water only. Exercise caution when cleaning windows because they can scratch easily.

Note the following instructions:

- Use generous amounts of fresh water to wash off dust.
- Use bare hands with plenty of water to dislodge any caked dirt.
- Use a soft, grit-free cloth or soft, clean sponge.
- Never use glass cleaning solutions or dusters, as they will scratch the surface.
- Do not use solvents such as acetone, kerosene, benzene, carbon tetrachloride, fire extinguisher fluid, dry cleaning fluid, lacquer thinner or any type of cleaning product containing these items, since they will attack the surface.
- When finished, rinse with fresh water and dry with a clean, damp chamois using a blotting action.

Stainless Steel

Stainless steel railings and fittings should be cleaned with neutral soap and water. Because irreversible pitting will develop under rust that remains on stainless steel for any period of time, it is best to remove rust spots immediately with a chrome cleaner. Then coat the railing or fitting with a good car or boat wax. Never clean with mineral acids or bleaches. Also, do not allow stainless steel to come into continuous contact with iron, steel or other metals which could cause contamination leading to rust or corrosion.

Seats

Please ensure you regularly remove all seats from floor positions and clean thoroughly. Seats may seize or bind if permanently left in place.

The seats fitted to your vessel are rated to 75kg passenger weight.



WARNING

The seats or lounges are not to be stood on, or used as steps to enter or exit the boat. This practice could cause injuries to the boat occupants and also damage the seat and or fabric.

Fabrics

Prior to cleaning any fabric, we suggest testing the cleaning solution on an inconspicuous area.

Vinyl tops and upholstery can be cleaned using a neutral soap and water solution. Vinyl cleaners and conditioners are not recommended for use on upholstery. To prevent rainwater seepage at the seams, a coating of Scotch Guard can be applied on the inside of the vinyl top.

Mildew can occur if the boat does not have adequate ventilation. Heat alone will not prevent mildew. If mildew does occur, it can often be removed using a solution of hot water and laundry bleach (as per manufacturer's instructions). Brush the solution into the affected area, leave for 10 to 15 minutes and rinse with plenty of fresh water. If possible, the vinyl top parts of your boat should be stored indoors in a fairly warm, dry place. This will greatly extend the life of the material. Dry cleaning should be considered for interior fabrics other than vinyl.

Canopy/Bimini Care

Our canopies and biminis are made from 100% solution dyed acrylic fibre that has a fluorocarbon finish for excellent water repellence. Canopies and biminis should be cleaned regularly. The fabric can be cleaned without being removed from the frame. Simply brush off any loose dirt, hose down and clean with a mild natural soap in lukewarm water. Rinse thoroughly to remove soap. Do not use detergents.

WARNING



Insure canopies and bimini are stowed before trailing the vessel. Towing the vessel with the canopy or bimini in the up position could affect the vessels warranty.

Instruments and Gauges

When instruments are exposed to a saltwater environment, salt crystals may form on the bezel and plastic covers. These salt crystals should be removed with a soft, damp cloth; never use abrasives or rough, dirty cloths to wipe plastic parts. Neutral household detergents or plastic cleaners can be used to keep the instruments bright and clean.



WARNING

Do not place vessels in salt or chlorinated pools.

Hull, Paint Service and Warranty

To maintain the appearance and value of your boat, it is necessary to perform regular maintenance using the proper procedures. Always maintain your boat in compliance with any pertinent environmental pollution control regulations. Carefully select the products to be used for washing etc., to be sure they do not contain corrosives. If in doubt contact your authorised dealer for assistance.

Oxidisation

Aluminium reacts naturally with the environment and produces a protective coating called oxide. This process is called oxidisation. Salt and moisture are very common causes of oxidisation in boats and is a normal reaction.

In a painted boat, this reaction can cause the paint to bubble and flake off in areas throughout the boat where the paint seal has been broken and allowed moisture to enter. This is only a cosmetic reaction and will not affect the boat structurally.

Should oxidization affect the paint work some maintenance will need to be carried out to retain the appearance of your vessel:

- Sand the affected area removing the bubbled paint and any signs of oxidisation. Feather in the edges of the remaining paint work.
- Clean the area of all contamination using a prep sol.
- Mask off the areas not being repaired.
- Apply a suitable etch primer to the sanded area and allow to dry.
- Apply the top coat to the area to be repaired and allow to dry.
- After allowing the paint to dry' buff the area to blend in the repair.
- Advice and materials for this type of maintenance can be obtained from your local dealer.

In unpainted boats most customers do not realise this reaction is occurring because there is no paint to bubble and flake. The reaction is shown by the normal dull appearance unpainted boats develop over time.

WARRANTY POLICY

Paint is warranted against defective paint or application, NOT against the normal effect of oxidisation around unsealed edges and fittings. Oxidisation is normal for aluminium boats and is only cosmetic if not caused by a dissimilar metal. Salt and moisture reacting with the aluminium will not affect the boat structurally.

WARNING



Cleaning products can be dangerous. Some are poisonous, others can ignite or react with a hot part of the vessel, e.g. outboard motor. Some are dangerous if the fumes are inhaled in an enclosed space. When using anything to clean your boat, be sure to read and follow the manufacturers instructions.

Never use the following to clean your boat:

- Petrol
- Benzine
- Carbon tetrachloride
- Acetone
- Paint thinner
- Turpentine
- Lacquer thinner
- Nail polish remover
- Or any products containing these or similar items.

The Hull

Marine aluminium does not need to be painted for protection from the elements, unless the boat is moored permanently for long periods. It is already highly resistant to corrosion and will not deteriorate if simple precautions are taken.

Always wash the boat off with fresh water after removing it from the water. This alleviates corrosion-causing surface oils and dirt.

Cleaning Unpainted Boats

The shiny finish on unpainted boats will normally develop a surface oxidation film over time. This film is usually dull in colour and will actually protect the metal beneath indefinitely with nothing more than an occasional wash. However, the bright aluminium finish can be restored by following this recommended procedure:

- Remove all surface dirt and oils. Note Some washing detergents are highly alkaline or acidic. These will remove the protective surface oxidation film and must not be used.
- Rinse with plenty of fresh water and dry the boat with a clean, damp chamois.
- Polish the hull surface with an abrasive compound or automotive aluminium wheel cleaner. Follow the directions provided in the polish manufacturer's instructions.
- Be aware the oxide will return, this is a natural aluminium reaction to outdoor elements.

Cleaning Painted Boats

The following soiling left on your boat may cause corrosion, discolouration and stains - wash them off as soon as possible:

- Seawater
- Anti-freeze from road travel.
- Soot and dust, iron powder from factories, chemical substances such as acids, alkalis, cola tar etc.
- Bird droppings, insect carcasses, dried old bait, sap, fertilizers etc.

Washing

Chemicals contained in the dirt and dust picked up from the road and prolonged exposure to dried salts from seawater, can damage the paint coating and aluminium of your boat. Frequent washing with fresh water is the best way to protect the boat from this damage. Ensure the bung/s are removed and increase the height of the jockey wheel (leave boat permanently tilted) on the trailer to allow residue water drain after use.

After each use spray with fresh water to remove the salt and dust. Next, using ample fresh water and a sponge or soft car washing brush, wash the boat from top to bottom.

Rinse thoroughly and wipe dry with a chamois or soft clean cloth. After washing carefully clean and dry joined panels around fittings etc. where moisture and salt is likely to remain. After washing allow the hull to dry thoroughly before storing undercover. The vessel should be left outside to dry for at least 3 days to insure all moisture in the vessel and carpet is dry.

Polishing

The boat should only be polished if the paintwork has become stained or lost its lustre. Polishing does remove some of the paint's film thickness.

Damaged Paint

Small cracks and scratches in the paint coating should be touched up as soon as possible with the touch-up paint supplied with your boat. Check the boat regularly for damage from oxidisation, flying stones, bait knives, anchors and chains etc.

Special Care for Moored Boats

If permanently moored in salt or fresh water, your boat will collect marine growth on the bottom. This will detract from the boat's beauty and greatly affect its performance. There are two methods of preventing this:

Periodically haul the boat out of the water and scrub the bottom with a bristle brush and water.

It is recommended to paint the hull below the waterline with a good grade of antifouling paint if permanently moored.

NEVER use red lead or red oxide primers.

NEVER use mercury, arsenic or copper-based bottom paints, since these may cause electrolysis on some of your boat's metal parts.

When the boat is out of the water, frequently check all metal parts for stray current erosion. Stray current erosion, or electrolysis, can be prevented in several ways. The best way is to fit isolator switches, and turn it off when the vessel is not in use, this will disconnect the battery from the vessel's electrical systems.

CAUTION



Do not use petrol or paint thinners to remove road tar or other contamination from the painted surface.

CAUTION



When washing the windscreen use only fresh water.

CAUTION



Never use any form of acids or alkalis to remove contamination or to wash the boat. Besides being harmful to the paint film, it can do great damage to the boat's structure.

CAUTION



Only use paints recommended by paint experts as safe and suitable for use on aluminium boats.

IMPORTANT NOTICE ABOUT ETHANOL

The use of ethanol in fuel is increasing as an alternative to petroleum based fuel and used in reformulated (oxygenated) fuels, however, some drawbacks you may encounter to this technology for use with marine fuel tanks are:

- Corrosion of metal parts
- Deterioration of rubber or plastic parts
- Fuel permeation through rubber fuel lines

What is Ethanol?

- Ethanol is an alcohol made from sugar cane, wheat and many other organic materials
- Ethanol is often blended with gas (E10) and has been used in the automotive industry since the early 1980s

Why E10 Blends?

- Ethanol can be used to meet EPA requirements for a cleaner burning fuel
- Ethanol slightly improves Octane Rating
- Ethanol can help reduce our dependence on foreign oil

E10 Blend - Properties

- E10 absorbs water readily and easily
- If sufficient water is absorbed, “phase separation” can occur-water and ethanol will settle to the bottom of the tank and fuel will be on top
- Phase separation cannot be reversed with agitation or fuel additives
- Boundary layer can contain corrosive compounds which can cause corrosion in aluminium fuel tanks

E10 Blends - Compatibility

- Water contamination of fuel is the big issue and concern
- The best advice we have for customers is to empty the fuel tanks for long term storage. Alternatively, keeping the fuel tank full reduces the amount of exchange between the fuel and air that might bring in condensation

Phase separation essentially means that the ethanol in the fuel has attracted water (usually already present from condensation and/or other sources) into the fuel mix. When the right amount of water enters the mixture, most of the ethanol and water will tend to separate from the fuel (into a different “phase”) and drop to a lower level or layer inside the tank (water is heavier than fuel). If this layer of concentrated ethanol and water is drawn into the engine’s fuel system, significant damage can occur. Further, the level at which phase separation occurs is determined by a number of variables, one of which is the temperature of the environment. This may help to explain why some regions of the country may be more affected by ethanol than others

Ethanol has very different solvency behaviours than fuel and is a proven contributor to the deterioration of certain rubber and/or plastic components. Telwater is aware of this potential and is constantly working to implement material improvements to better withstand the effects of ethanol. Telwater continues to monitor the ethanol situation worldwide and makes every effort to upgrade materials as necessary to ensure the continued reliable, durable operation of all of its products.

Phase Separation

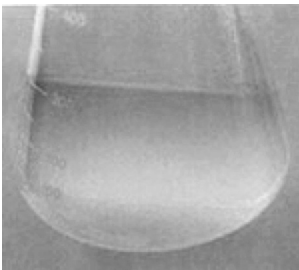

Trailer Information

Maintaining the trailer

Galvanised trailers are coated in a galvanised finish. This chemical process bonds very hot liquid zinc to the trailer and its components. The zinc covering forms a barrier that protects the steel under the zinc. The environment in which the trailer is used, stored and maintained determines the level of deterioration of the zinc. In areas of high humidity, high salinity or poor water quality, it is common for the zinc finish to deteriorate very quickly. A high level of care is required in these environments.

Trailers must be washed thoroughly after use and stored in a dry, well ventilated area. Salt residues may drop onto your trailer from the hull above while in storage. If this occurs, wash as soon as possible.

It is normal as the zinc surface ages that a white powder (calcium carbonate) forms on the galvanised components. Calcium carbonate is normally evident in the low drainage points of the trailer where salt residues collect.

Couplings

Connect the coupling to the tow bar by placing the coupling directly over the ball, pull up the handle and let the coupling slide down over the ball then release the handle letting it bottom out on the top of the coupling. Mechanical, hydraulic and standard couplings need to be greased every six months or when there is no grease present on the shafts.

Safety Chains

Connect the safety chain to the vehicle with D shackle supplied with the trailer. Do not use a padlock between the safety chain and the car while travelling.

Jockey Wheels

When manoeuvring the trailer on either concrete, lawn or a soft surface, the jockey wheel should be in its wound down position. This enables easier manoeuvring of the trailer.

Axles and Springs

It is recommended that the suspension components be inspected at least twice yearly for any evidence of loose u-bolts, bolts and corrosion or breakage of the leaf springs. Painted and galvanised suspension components should be sprayed regularly with products such as lanolin based sprays.

Wheel Bearings

Wheel bearings should be checked at least every 90 days and before putting the boat away for any lengthy period. They should be replaced every 6 months

depending on trailer use.

For a quick check, jack up the wheel and give it a wobble from side to side:

If there is slack in the bearing you will need to retighten the axle hex nut and give the wheel a spin.

If it is noisy you will need to change the bearings.

If you re-assemble the hub and there is evidence of water, this will also render the bearings unfit for use and require replacement.

Routinely check the wheel hubs whenever you stop for fuel or refreshments. If the hub feels abnormally hot, inspect the bearings before continuing. On extended trips, carry spare wheel bearings, seals and races.

Brakes

If your trailer is braked, the braking system is a disc brake over-ride system with either mechanical (cable operated) or hydraulic (fluid operated) brakes.

At any sign of deterioration, mechanical brake cables need to be replaced. To adjust the tension on mechanical brakes ensure the boat, motor and all equipment are on the trailer. The cable can then be adjusted at the front pulley or the adjustment bolt on the calliper. Remember to leave enough slack in the cable to allow for the flex in the trailer while underway.

Trailers with a gross mass over two tonnes are fitted with hydraulic electric braking system and disc braked on all four wheels. This system needs an in-car electronic electric brake controller to operate it correctly, owner supplied and fitted by an auto electrician. The braking unit must be mounted high over the coupling and kept clear of submersing and high pressure cleaners at all times.

It is important to check the trailer's brakes for operation prior to departure on each trip.

Alloy and Steel Wheel Stud Patterns

Alloy 9", 10", 13" and 14" wheels - stud size: 7/16", pitch circle diameter: 108mm (41/4 commonly called HT).

Tyres

Correct tyre pressures are located on the yellow sticker at the front of your trailer and on the tyre's side wall. Regular checks for the correct inflation pressure and uneven tyre wear should be carried out. It is recommended for maximum tyre life that the tyres be rotated on the rim every 12 months or 6 months for heavy use. It is also recommended that a spare wheel is carried along with the tools required to change them.

WARNING



Wheel nut torque on the trailer wheel and the spare wheel should be checked at regular intervals.

Trailer Frame Drainage

It is important that the drain holes throughout the trailer frame are kept clear and checked on a regular basis. This allows for drainage of any trapped water to exit the frame.

Trailer Lighting

Lighting and wiring need a six month inspection to ensure that there is no cracked lamp lenses, no corrosion has got into the wiring, lamps and that all functions of the lamps are working.

Check tail lights and turn signals work when attached to the towing vehicle. Before backing the trailer into the water, disconnect the light plug from the car. This will greatly reduce the chance of blowing out the trailer lights.

Hand Winch

Never overload your winch, use it only for the application it has been supplied for on normal ramp conditions. All winches are fitted with webbing straps (the same material as seat belts). This material is designed for higher load rating and braking strain, compared to equivalent cable.

When you finish with the trailer remember to check that the winch strap is dry to avoid rusting on the winch drum. Oil the winch shafts, bushes and gears periodically when needed.

Fitting Boats to the Trailers

The boat should sit hard on all keel rollers. Galvanised parts should not be touching any part of the hull and the side Teflon skid pads should be positioned as far out from the keel as possible then to be adjusted up firm against the hull of the boat.

If your boat doesn't come up straight after trailer adjustment and all skid pads and roller measurements are correct, then check that the boat sits horizontal in the water. Even a very slight lean will bring the boat up to one side. Move fuel tanks, fishing gear etc to bring the hull horizontal to the water.

The boat should be fastened to the trailer by a cable or strap from the bow eye to the winch, plus a safety chain or cable from the bow eye to the winch stand or trailer tongue. The stern of the boat should be tied down to the trailer. Tie down points are fitted to

podded models. These are to be used as tie down points. The boat transom-to-trailer tie down straps and winch lines are designed for normal towing conditions on paved roadways and moderately rough secondary roads (at slow speeds only). We recommend the use of additional straps or rope tie downs for securing the boat to the trailer, particularly for longer trips or whenever you expect to encounter rough roads. The use of a motor support bracket is also recommended.

Trailer Tips

HANDY TIP



Remember to close all hatches and doors in the boat before trailering. Store all loose equipment, so it cannot slide, fall or blow out. Ensure the canopy/bimini is down and secure and that all seating inside the boat is also secured. It is possible for seats to move while travelling – ensure all seats are strapped down and securely fastened.

HANDY TIP



Do not use your boat as a trailer. Do not carry excess weight in the boat while trailering or travelling on the water.

HANDY TIP



When reversing, engage the reverse lock on the trailer hitch. This will lock on the trailer hitch and stop the trailer brakes operating when reversing. Remember to disengage the lock when the reversing operations are complete.

HANDY TIP



Too much or too little tongue weight will cause difficult steering and tow vehicle sway. Generally 5% to 10% of the boat and trailer weight should rest on the tongue.

Nautical Terms

Abeam	On either side of the boat.
Aft	To the rear, or near the stern.
Beam	The width of the hull.
Bilge	The lowest portion inside a boat (in a recreational boat, generally the under deck and lower portion of the engine compartment).
Bow	The forward portion of the boat.
Bulkhead	Vertical partition in a boat.
Chine	The intersection of the side and bottom of a V-bottom boat.
Cleat	Deck fitting with arms or horns on which lines may be fastened.
Draft	Vertical distance from the waterline of the boat to the lowest point of the boat.
Fathom	A measurement of six feet, generally used to measure water depth.
Fender	A protective device (usually made out of a rubber like material) placed between the boat and dock to prevent abrasion and damage.
Freeboard	Vertical distance from the deck to the waterline.
Gunwale	The point where the hull and deck meet.
Hatch	A covered opening in the deck.
Head	Toilet or toilet room.
Helm	Steering wheel.
Hull	The basic part of a boat; a watertight vessel that provides buoyancy to float the weight of the craft and its load.
Keel	The lowest external portion of the boat.
Knot	Nautical mile per hour; one nautical mile is 6,076 ft; a land mile is 5,280ft.
Lee	Opposite side from which the wind blows.
Mayday	International spoken distress signal for radiotelephone communications.
Port	To the left side of the boat (when facing forward).
Porthole	A hinged window in the boat's cabin or hull.
Scupper	An opening in a deck or cockpit permitting water to drain overboard.
Stanchion	A fixed, upright post used for support (of rails or lifelines).
Starboard	To the right side of the boat (when facing forward).
Stern	The rear of the boat.
Stern Drive	Inboard engine/outboard propulsion unit.
Transom	The vertical part of the stern.
Wake	Track or path a boat leaves behind while in motion.
Windward	The direction from which the wind is blowing.

WARRANTY

Our goods come with guarantees that cannot be excluded under the Australian Consumer Law. You are entitled to a replacement or refund for a major failure and for compensation for any other reasonably foreseeable loss or damage. You are also entitled to have the goods repaired or replaced if the goods fail to be of acceptable quality and the failure does not amount to a major failure.

3+2 Year Limited Hull Warranty

Telwater Pty Ltd: Our liability for boats of our own manufacture is limited to making good any defects by repairing the same or, at our option, by replacement within a period not exceeding thirty six (36) calendar months after the boat has been sold by our dealer for the first time, subject to the Telwater Three Year Limited Warranty Special Provisions. (For warranty conditions on your Outboard motor and TELWATER Trailer, refer to their applicable owners' manual supplied with these items)

Special Provisions:

1. The boat must be maintained and used in accordance with the Boat Capacity Plate and Necessary Maintenance Directions attached to the boat and owner's manual.
2. The boat and/or outboard/inboard engine must not have been altered or operated outside safe boating practices or the limits of the design specifications set down in the brochure or owner's manual.
3. The boat has not been damaged by neglect, accident, improper use or used for competitive purposes.
4. The warranty does not cover any consequential expenses beyond the warranty repair of the boat itself, e.g. Freightling.
5. Telwater Pty Ltd shall not be liable for consequential loss of any kind arising out of the supply or operation of the boat or any item(s) installed by Telwater Pty Ltd.
6. Paint is warranted against defective paint or application, NOT against the normal effect of oxidation and degradation caused by fuel and dissimilar metals.
7. The normal effect of oxidation of aluminium has the potential to bubble paint surface finish. Surface contaminants could cause oxidation if not removed from the vessel.
8. Internal side panels are warranted against defects and not against degradation caused by fuel.
9. The fitting of wedges and anti-ventilation plate foils to the outboard/inboard engine could void the warranty (refer to special provision 2).
10. Any work agreed to be repaired by Telwater will be done ex. factory, and freightling costs to and from the

factory will be the purchaser's responsibility. The warranty does not cover items replaced during normal service and maintenance operations and which are subject to wear. These arrangements apply regardless of any change in ownership during the period covered.

11. Subject to item 12, the above warranty is in lieu of any and all warranties expressed or implied, conferred by statute or otherwise and is the only warranty given by Telwater on the boat or any part thereof. Any warranties under the Sale Of Goods Act are expressly excluded.

12. All warranties and conditions implied under the Australian Consumer Law, including as to one of merchantable quality, are not excluded by this warranty except that Telwater limits its liability for breach to:

- a. the replacement of the boat or products;
- b. or the repair of the boat or products,

at Telwaters' option with all freightling costs to be the purchaser's responsibility.

13. Excludes windscreen/windshield breakage and leakage around windscreens/windshields or other designed openings.

14. Telwater provides a general warranty as to the fitness for the purpose for the period of 12 months from the date of purchase with regard to upholstery, including lounges, backrests and seats.

15. Telwater will NOT warrant boats, which have been improperly trailed. E.g. the use of multi roller trailers, Incorrect or insufficient tie down from vessel to trailer, no engine support through an engine support bracket and off road use.

Commercial Use

Telwater Pty. Ltd. does not warrant boats used commercially or warrant that boats are suitable for your particular commercial application. It is a condition of the sale to you of any boat or Telwater product that the warranties and special provisions as set out above form part of the contract of sale between Telwater and you.

IMPORTANT

The contents of this owners manual excluding Warranty and Warranty provisions, will not form part of any contractual agreement. Telwater recommends that all persons comply with their local boating regulations and are familiar with safe boating practices. This owners manual is designed to provide you with an introduction to the Telwater products. Telwater* reserves the right at any time, at its discretion, and without notice, to discontinue or change the features, designs, materials, colours, specifications and the prices of its products, and to either permanently or temporarily withdraw any such products from the market without incurring any liability to any prospective

purchaser. Details referred to in this owners manual are based on pre-production specifications and could be altered or deleted prior to the boat's sale date. Because of variations which occur in manufactured products, all capacities, measurements, dimensions and weights quoted should be taken as approximates only and are subject to change. Every effort has been made to depict boat colours and trims as realistically as possible in this owners manual; however some variation may occur due to printing limitations. Always consult with an authorised Telwater dealer for the latest information with respect to features, specifications, prices, optional equipment and availability before deciding to purchase. Telwater do not offer factory direct sales or prices. For updated specifications, please refer to the Telwater website www.telwater.com.au

Telwater Boats now eligible for an additional 2 year bonus Warranty

As of 1st March 2016 Telwater will now be offering an additional 2 year bonus warranty after the existing 3 year Telwater warranty expires. This provides the end consumer with a total of 5 years factory backed warranty on any new boat purchases.

Telwater will now provide an additional 2 year structural warranty on the boat and trailer (including labour.) All new BMT, BT and boat only purchases are eligible for this bonus warranty. This warranty covers failures caused by defect in material or factory workmanship.

Standalone trailer orders are exempt from this bonus warranty.

The 2 year warranty extension will terminate upon failure to meet any of the Warranty Conditions.

Warranty Conditions to attain extended Warranty:

- 20 hour / 3 month inspection, followed by annual inspections up to year 5 from purchase date must be performed and documented online with Telwater by an approved Telwater dealer.
- If the boat has been inspected at these intervals since purchase date it is eligible for the extended structural warranty.
- Customers must log services in the Telwater owner's manual and retain all invoices for their records.
- Dealer must log service details online with Telwater.
- Warranty coverage becomes available upon registration of the product online with Telwater.

It is a requirement to register every new boat within 10 calendar days from the date of delivery to the customer, Failure to do will jeopardize your Telwater dealer agreement and most importantly engage your liability in the event of

an accident related to a safety recall not performed. All registrations must reflect:

- the true date of delivery of the unit to the retail customer;
- the model and serial number;
- the name and the complete address of the customer, including phone number
- It is the dealer/distributor's obligation to identify and explain the conditions of the 3 + 2 warranty program.

Warranty Period Coverage:

Provided that the extension Warranty Conditions have been met the additional 2 Year warranty coverage will commence once the product's standard limited warranty period (3 years) has expired. The total duration of the coverage will be five (5) years. Unexpired warranty coverage can be transferred to a subsequent purchaser upon proper re-registration of the product with Telwater online.

Modification/Alteration:

Any Products that have been modified or altered from their original production configuration may be excluded from any Telwater warranty coverage. The addition of, or replacement with, parts or accessories not approved by Telwater, or not installed by an Authorised Telwater dealer, may be cause for your 3 + 2 Telwater warranty to be void. This will also be applicable to your standard 3 year warranty.

Trailer Warranty

Frame Warranty:

Telwater warrants each boat trailer frame and its fabricated steel components including the ball coupling and wheels (but excluding tyres and tubes) to be free of structural or welding defects for a period of three years from the date of original purchase.

One Year Limited Warranty:

Telwater warrants the hot dipped galvanized finished surface of each trailer and its components for one year from the date of manufacture on the compliance plate against red rust. This warranty extends to u-bolts, nuts, bolts, mechanical braking equipment (excluding disc brake surface, brake cables and adjusters) and the manual winch but excludes the strap or cable.

Telwater provides a general warranty as to the fitness for the purpose for the period of 12 months from the date of purchase with regard to trailer springs, winch and equipment and trailer plastic guards.

Six Month Limited Warranty:

Telwater provides a general warranty as to fitness for purpose for a period of six months from the date of

original purchase with regard to trailer lighting, hydraulic and mechanical braking equipment, axles, wheel bearings (excluding water entry), seals, tyres (excluding wear), the surface finish of painted or powder coated wheels and jockey wheels.

Obligations of Telwater:

Telwater Pty Ltd: Our liability for trailers of our own manufacture is limited to making good on the above warranties, any defects by repairing the same or, at our option, by replacement after the trailer has been sold by our dealer for the first time.

Special Provisions:

- Exercise of any of the above Warranties is subject to delivery of the trailers to Telwater, to proof of purchase and the date of purchase (as to which Telwater's records shall be conclusive in the case of disagreement).
- This warranty does not cover the cosmetic appearance of the galvanised surface of a trailer or its components. It does not extend to rust on painted and zinc coated surfaces. It does not cover wear and tear or cosmetic changes to brake pads, winch cables, winch straps, bow rollers and keel rollers.
- This warranty does not extend to any trailer which is found to have been used for any purpose other than that for which it was manufactured, which is found to be overloaded, which is altered or modified in any way, or which malfunctions due to prior damage, unreasonable use or failure to provide reasonable and necessary maintenance.
- This warranty will be negated by and Telwater will not bear any responsibility for any warranty procedure or charge carried out without written authorisation by Telwater.
- There shall be no implied or actual warranty with respect to the manufacture of, merchantability, or fitness for a particular purpose of any Telwater trailer and Telwater shall not be liable for any transportation charges, or for any direct, special, incidental, consequential (including loss of profit) or other loss or damage, whether based in contract, tort, or arising from breach of any warranty or otherwise provided that Telwater acknowledges that this warranty does not exclude or limit the application of any provision of any statute (including the Australian Consumer Law) where to do so would contravene that Statute or cause any part of this agreement to be void ("non-excludable condition"). Telwater's total liability hereunder for a breach of any non-excludable condition (other than implied by Sections 51-53 of the Australian Consumer Law) is limited at its option to any one of supplying, repairing or replacing or paying the

cost of supplying, repairing or replacing a trailer.

- Commercial Use or Off Road Use: Telwater Pty Ltd does not warrant trailers used commercially or off road or warrant that Telwater trailers are suitable for a particular commercial or off road application.

In the event that a claim needs to be made you should contact a Telwater Dealer. The Dealer will then process the claim on your behalf. You can find out who your nearest Dealer is by visiting www.telwater.com

Telwater Pty Ltd
53 Waterway Drive
Coomera QLD 4209

Telephone: 07 5585 9898

Email: warranty@telwater.com

Pre Delivery Service

Not Applicable	Check/ Adjust	Pre Delivery Service
		Check and torque seat and pedestal screws
		Check esky seat boxes for security
		Check operation of bilge pump and float switch
		Check operation of live bait pumps
		Check operation of navigation lights and cockpit lights
		Check steering system for freedom of movement and any hydraulic leaks (mechanical and hydraulic)
		Check security of canopy
		Explain warranty conditions to customer
		Carry out water test
		Trailer Pre Delivery Service
		Check trailer adjustment to vessel
		Check and adjust brake cable
		Check operation of trailer lights
		Carry out general check over of trailer for security of bolts and fittings
		Check tyres for serviceability retorque wheel nut and check tyre pressure
		Engine
		Carry out engine service in accordance with engine manufactures service schedule

Dealer Stamp

Date

Workshop Manager Signature

20 Hour Service / 3 Month Service

Not Applicable	Check/ Adjust	10 Hour Service
		Check and torque seat and pedestal screws
		Check esky seat boxes for security
		Check operation of bilge pump and float switch Note: This does not apply to models with a fully welded floor
		Check operation of live bait pumps
		Check operation of navigation lights and cockpit lights
		Check side panel security
		Check hull for integrity
		Check bungs
		Check steering system for freedom of movement and any hydraulic leaks (mechanical and hydraulic)
		Check operation trim tab system (vessels 6.1 m and above)
		Check security of canopy
		Check security of battery and terminals
		Trailer 10 Hour Service
		Check trailer adjustment to vessel
		Check and adjust brake cable
		Check operation of trailer lights
		Carry out general check over of trailer for security of bolts and fittings
		Check tyres for serviceability retorque wheel nut and check tyre pressure
		Engine
		Carry out engine service in accordance with engine manufactures service schedule

Dealer Stamp

Date

Workshop Manager Signature

100 Hour or 12 Month Service

Not Applicable	Check/ Adjust	100 Hour or 12 Month Service
		Check and torque seat and pedestal screws
		Check esky seat boxes for security
		Check operation of bilge pump and float switch Note: This does not apply to models with a fully welded floor
		Check operation of live bait pumps
		Check operation of navigation lights and cockpit lights
		Check side panel security
		Check hull externally and internally for integrity
		Check bungs
		Check steering system for freedom of movement and any hydraulic leaks (mechanical and hydraulic)
		Check operation trim tab system (vessels 6.1 m and above)
		Check fittings and security of canopy/side curtains
		Remove floor and check floatation for degradation, security of fuel tank and fittings, security and condition of live bait and bilge fittings and hoses, hull integrity
		Check security of battery and terminals
		Trailer 100 Hour or 12 Month Service
		Check trailer adjustment to vessel
		Check and adjust brake cable
		Check operation of trailer lights
		Carry out general check over of trailer for security of bolts and fittings
		Check tyres for service ability retorque wheel nut and check tyre pressure
		Check/repack wheel bearings
		Check brake pads
		Engine
		Carry out engine service in accordance with engine manufactures service schedule

Dealer Stamp

Date

Workshop Manager Signature

100 Hour or 12 Month Service

Not Applicable	Check/Adjust	100 Hour or 12 Month Service
		Check and torque seat and pedestal screws
		Check esky seat boxes for security
		Check operation of bilge pump and float switch Note: This does not apply to models with a fully welded floor
		Check operation of live bait pumps
		Check operation of navigation lights and cockpit lights
		Check side panel security
		Check hull externally and internally for integrity
		Check bungs
		Check steering system for freedom of movement and any hydraulic leaks (mechanical and hydraulic)
		Check operation trim tab system (vessels 6.1 m and above)
		Check fittings and security of canopy/side curtains
		Remove floor and check floatation for degradation, security of fuel tank and fittings, security and condition of live bait and bilge fittings and hoses, hull integrity
		Check security of battery and terminals
		Trailer 100 Hour or 12 Month Service
		Check trailer adjustment to vessel
		Check and adjust brake cable
		Check operation of trailer lights
		Carry out general check over of trailer for security of bolts and fittings
		Check tyres for service ability retorque wheel nut and check tyre pressure
		Check/repack wheel bearings
		Check brake pads
		Engine
		Carry out engine service in accordance with engine manufactures service schedule

Dealer Stamp

Date

Workshop Manager Signature

100 Hour or 12 Month Service

Not Applicable	Check/Adjust	100 Hour or 12 Month Service
		Check and torque seat and pedestal screws
		Check esky seat boxes for security
		Check operation of bilge pump and float switch Note: This does not apply to models with a fully welded floor
		Check operation of live bait pumps
		Check operation of navigation lights and cockpit lights
		Check side panel security
		Check hull externally and internally for integrity
		Check bungs
		Check steering system for freedom of movement and any hydraulic leaks (mechanical and hydraulic)
		Check operation trim tab system (vessels 6.1 m and above)
		Check fittings and security of canopy/side curtains
		Remove floor and check floatation for degradation, security of fuel tank and fittings, security and condition of live bait and bilge fittings and hoses, hull integrity
		Check security of battery and terminals
		Trailer 100 Hour or 12 Month Service
		Check trailer adjustment to vessel
		Check and adjust brake cable
		Check operation of trailer lights
		Carry out general check over of trailer for security of bolts and fittings
		Check tyres for service ability retorque wheel nut and check tyre pressure
		Check/repack wheel bearings
		Check brake pads
		Engine
		Carry out engine service in accordance with engine manufactures service schedule

Dealer Stamp

Date

Workshop Manager Signature

100 Hour or 12 Month Service

Not Applicable	Check/Adjust	100 Hour or 12 Month Service
		Check and torque seat and pedestal screws
		Check esky seat boxes for security
		Check operation of bilge pump and float switch Note: This does not apply to models with a fully welded floor
		Check operation of live bait pumps
		Check operation of navigation lights and cockpit lights
		Check side panel security
		Check hull externally and internally for integrity
		Check bungs
		Check steering system for freedom of movement and any hydraulic leaks (mechanical and hydraulic)
		Check operation trim tab system (vessels 6.1 m and above)
		Check fittings and security of canopy/side curtains
		Remove floor and check floatation for degradation, security of fuel tank and fittings, security and condition of live bait and bilge fittings and hoses, hull integrity
		Check security of battery and terminals
		Trailer 100 Hour or 12 Month Service
		Check trailer adjustment to vessel
		Check and adjust brake cable
		Check operation of trailer lights
		Carry out general check over of trailer for security of bolts and fittings
		Check tyres for service ability retorque wheel nut and check tyre pressure
		Check/repack wheel bearings
		Check brake pads
		Engine
		Carry out engine service in accordance with engine manufactures service schedule

Dealer Stamp

Date

Workshop Manager Signature

100 Hour or 12 Month Service

Not Applicable	Check/ Adjust	100 Hour or 12 Month Service
		Check and torque seat and pedestal screws
		Check esky seat boxes for security
		Check operation of bilge pump and float switch Note: This does not apply to models with a fully welded floor
		Check operation of live bait pumps
		Check operation of navigation lights and cockpit lights
		Check side panel security
		Check hull externally and internally for integrity
		Check bungs
		Check steering system for freedom of movement and any hydraulic leaks (mechanical and hydraulic)
		Check operation trim tab system (vessels 6.1 m and above)
		Check fittings and security of canopy/side curtains
		Remove floor and check floatation for degradation, security of fuel tank and fittings, security and condition of live bait and bilge fittings and hoses, hull integrity
		Check security of battery and terminals
		Trailer 100 Hour or 12 Month Service
		Check trailer adjustment to vessel
		Check and adjust brake cable
		Check operation of trailer lights
		Carry out general check over of trailer for security of bolts and fittings
		Check tyres for service ability retorque wheel nut and check tyre pressure
		Check/repack wheel bearings
		Check brake pads
		Engine
		Carry out engine service in accordance with engine manufactures service schedule

Dealer Stamp

Date
Workshop Manager Signature